

5/16-18 Thread

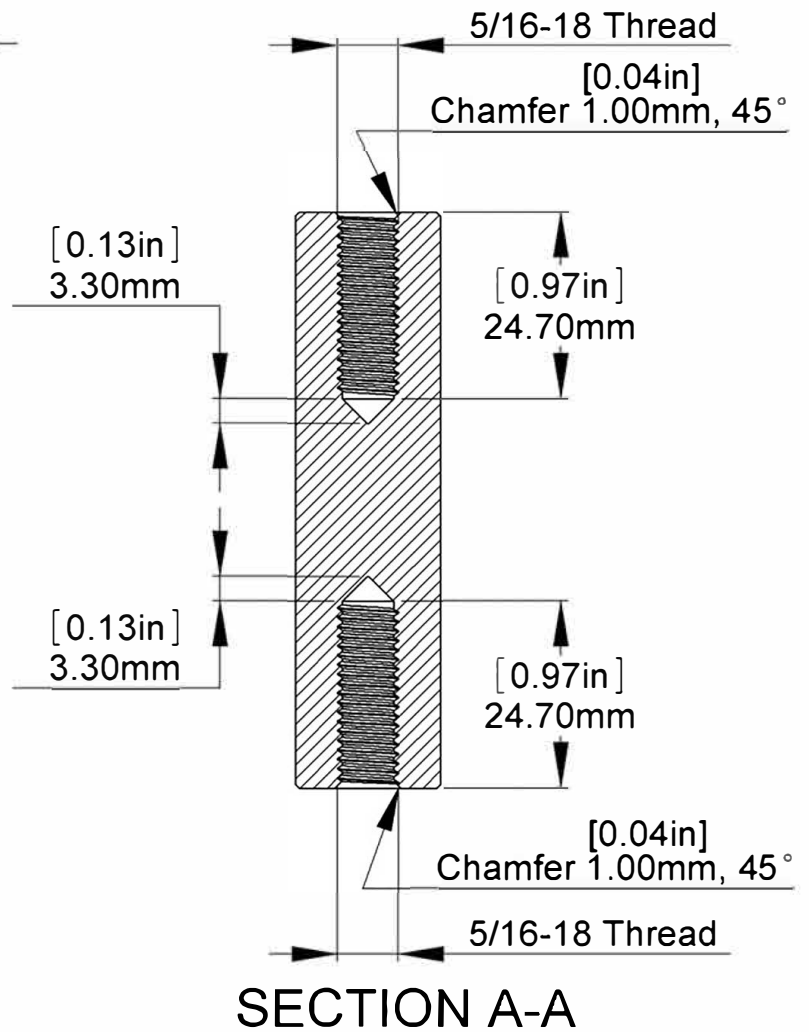

Title : **S075-300**

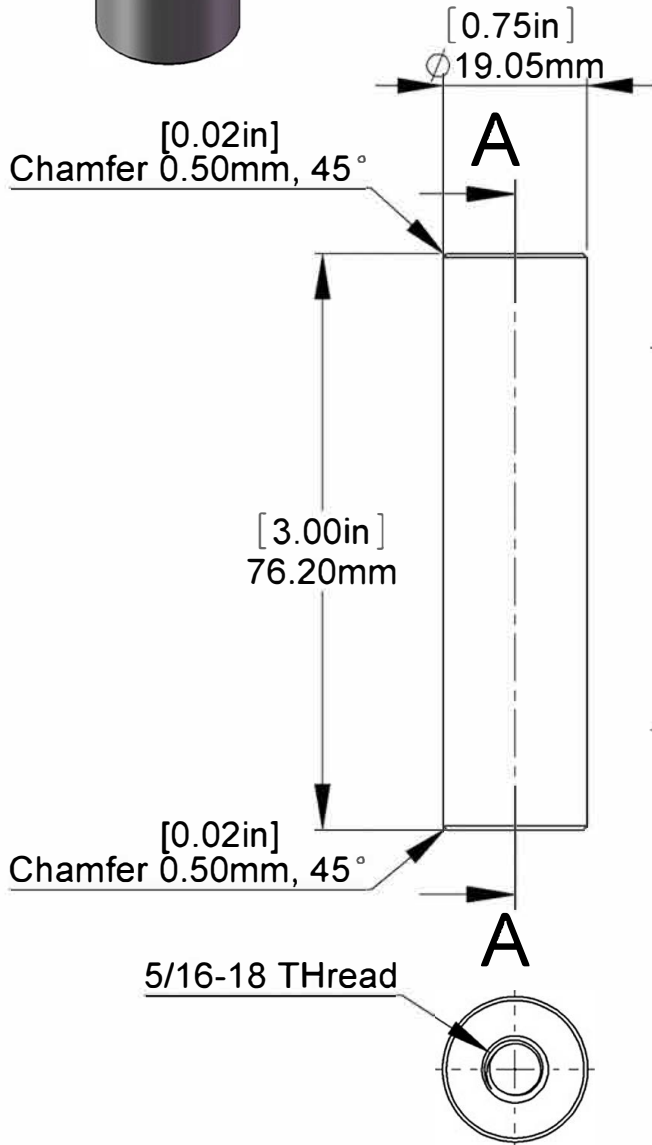

Scale : 1:1

Sizes : Letter Portrait

Customer:

Material:

Finish

Qty :

Rep :

N°programme laser

N°prog. Mécanum.

N° Plan : S075-300