

SECTION A-A
SCALE 2.5 : 1

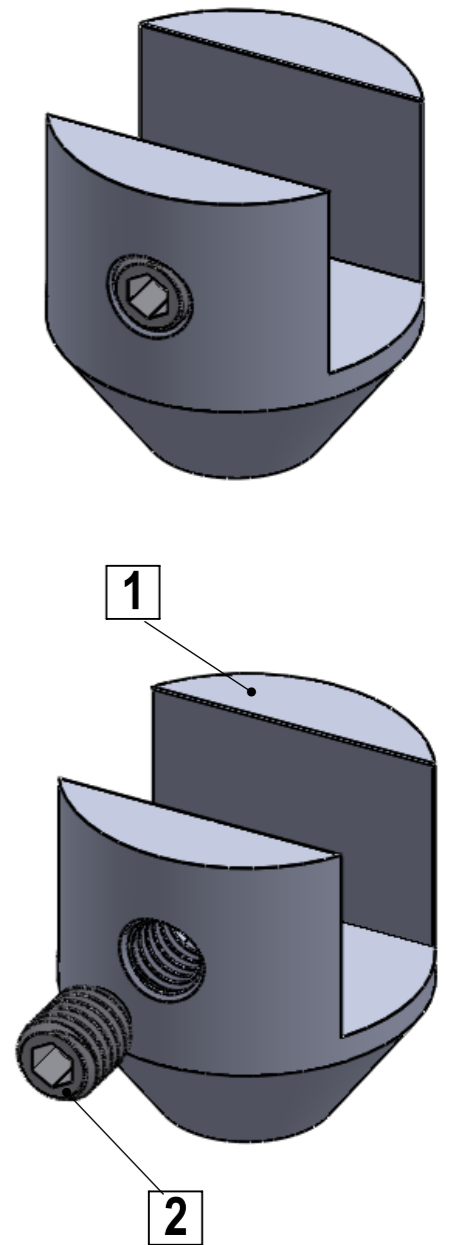

ITEM NO.	PART NUMBER	DESCRIPTION	QTY.
1	PS500		1
2	M6x8 with PE cap		1

Title : PS500			Scale : 2:1	Customer:	
			Sizes : Letter Landscape	Qty :	Rep :
Material:		Finish	N° Plan : PS500		
N°programme laser		N°prog. Mécanum.			