

Item	Qty.	Description
1	1	100.363 Body
2	1	100.268 Support (M10 Thread)
3	2	M4x6mm Set Screw

Title : 100.363

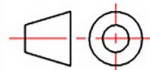

Scale : 1:1

Sizes : Letter Portrait

Customer:

Material:

Finish

Qty :

Rep :

N°programme laser

N°prog. Mécanum.

N° Plan : 100.363

100.363

100.383
100.385

100.362



Title :
Wire Cable set Ceiling to floor

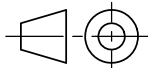

Scale : 1:5

Sizes : Letter Portrait

Customer:



Material:

Finish

Qty :

Rep :

N°programme laser

N°prog. Mécanum.

N° Plan : Wire Cable set Ceiling to floor

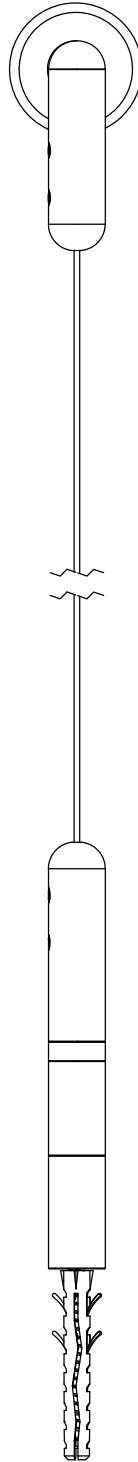
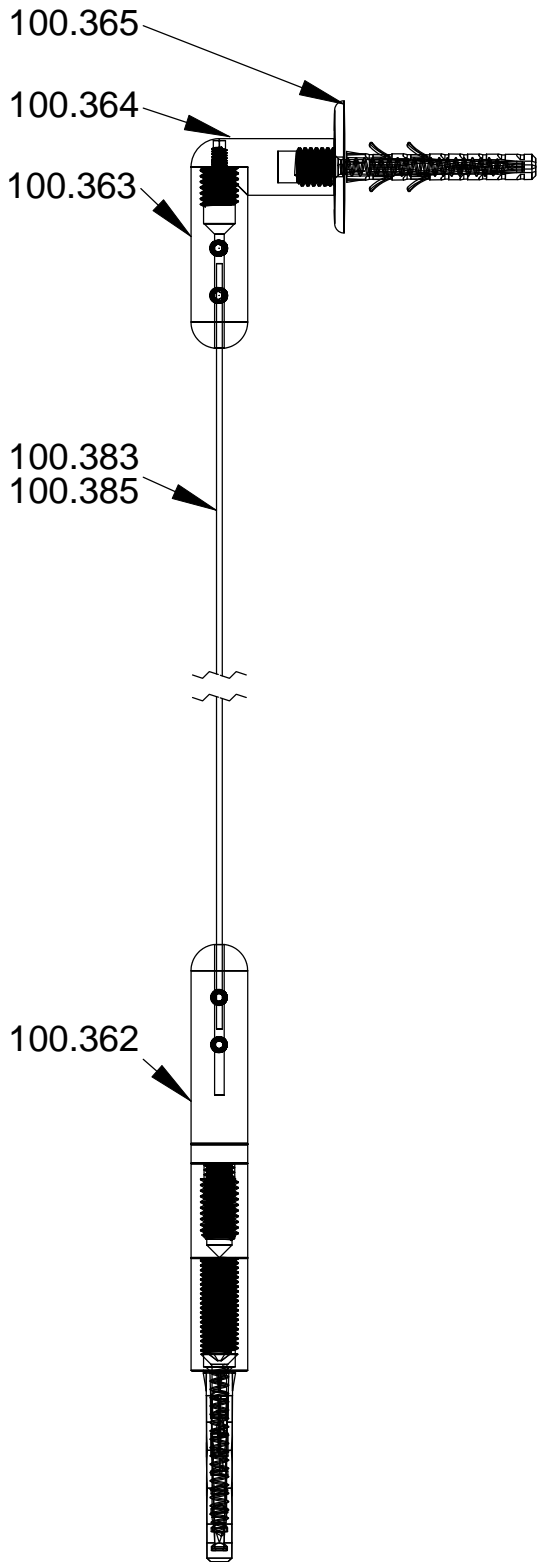

Title :
Wire Cable Set Wall to Floor

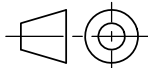

Scale : 1:5

Sizes : Letter Portrait

Customer:



Material:

Finish

Qty :

Rep :

N°programme laser

N°prog. Mécanum.

N° Plan : Wire Cable set Wall to floor

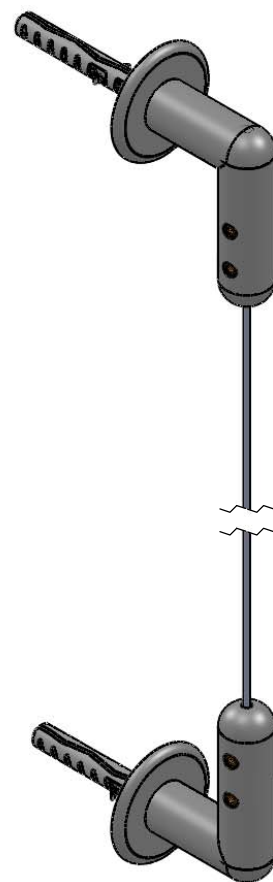
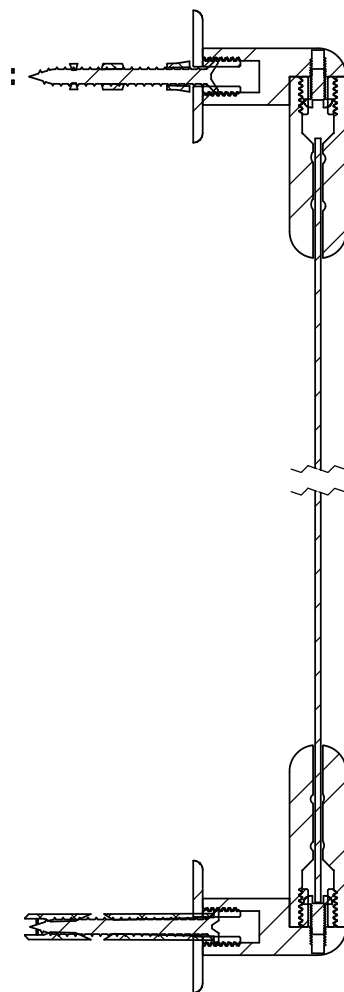
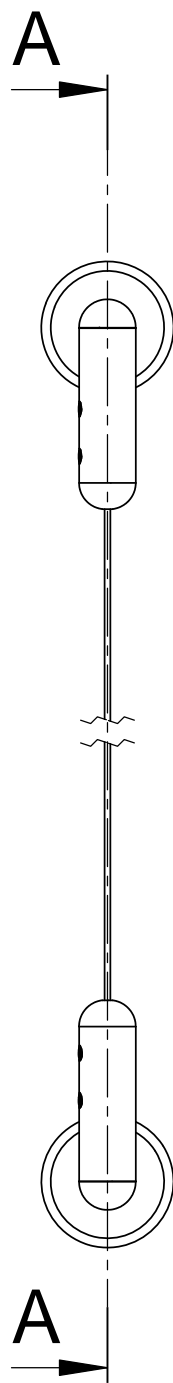
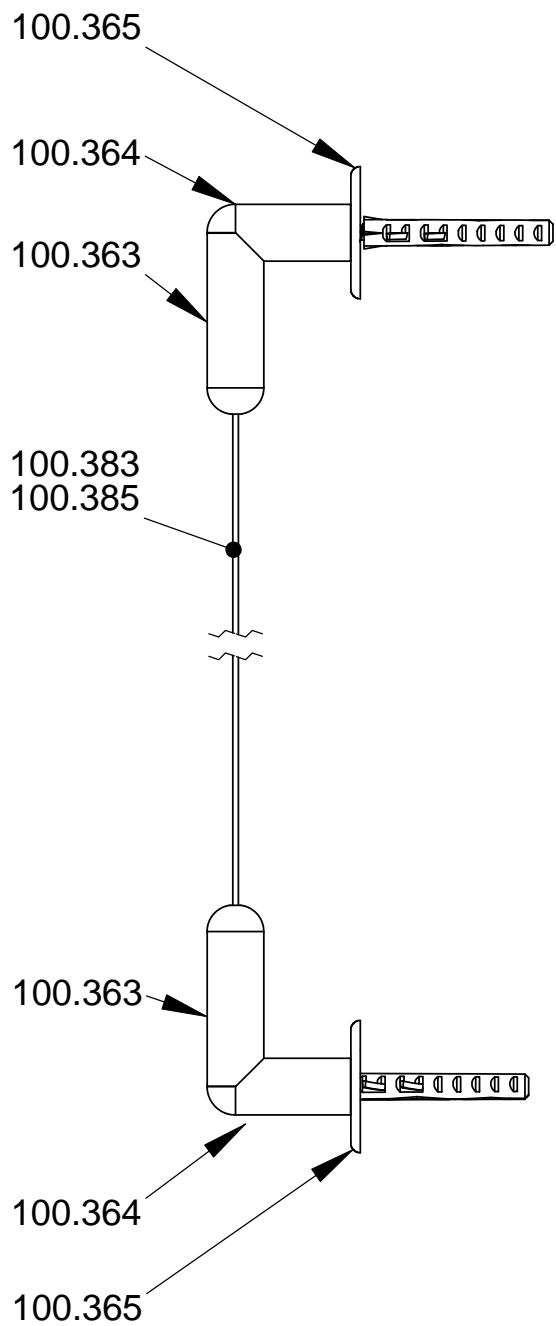

SECTION A-A
SCALE 1 : 2

Title :
Wire_Cable-Set_Wall_to_Wall

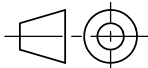

Scale : 1:5

Sizes : Letter Portrait

Customer:



Material:

Finish

Qty :

Rep :

N°programme laser

N°prog. Mécanum.

N° Plan : Wire_Cable-Set_Wall_to_Wall



Construction Examples:

